



ROOF-H Wentylator dachowy

The power of AIR



Zastosowanie

Wentylatory dachowe wyciągowe ROOF-H przeznaczone są do wentylacji:

- magazynów, hal sklepowych i przemysłowych, budynków gospodarczych w rolnictwie, etc.

Ze względu na wysoką odporność temperaturową zalecane są zwłaszcza jako odciąg:

- z nad rusztów, z okapów w przemyśle mięsnym oraz gastronomii.

Konstrukcja

- wirnik z łopatkami pochylonymi do tyłu, wykonany z blachy aluminiowej,
- podstawa wykonana z blachy aluminiowej,
- wsporniki i płyta nośna silnika wykonana z blachy nierdzewnej,
- czasza wykonana z blachy aluminiowej,
- siatka ochronna z blachy nierdzewnej,
- przystosowany do pracy w pozycji pionowej,
- montaż na dachach płaskich,
- temperatura pracy od -20°C do $+120^{\circ}\text{C}$.

Silnik elektryczny

- asynchroniczny, jednofazowy, 230V, 50Hz (o mocy do 1,1 kW),
- asynchroniczny, trójfazowy, 230/400V, 50Hz (o mocy do 3 kW),
- asynchroniczny, trójfazowy, 400/690V, 50Hz (o mocy od 4 kW),
- stopień ochrony IP55,
- klasa izolacji F,
- przystosowany do regulacji częstotliwościowej (silniki trójfazowe).

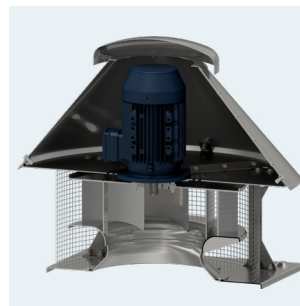

POWIĄZANE PRODUKTY



ROOF-V
Wentylator
dachowy
z wyrzutem
poziomym





DANE TECHNICZNE

model wentylatora	wydajność maksymalna	ciśnienie maksymalne	prędkość obrotowa	napięcie nominalne	natężenie znamionowe**	moc silnika	poziom ciśnienia akust.*	masa jednostki	numer artykułu
SILNIKI CZTEROBIEGUNOWE JEDNOFAZOWE									
ROOF-H/25/12/14S	1 220 m ³ /h	185 Pa	1 420 rpm	1~230 V	1,4 A	0,18 kW	54 dB(A)	17,0 kg	43534396
ROOF-H/28/17/14S	1 700 m ³ /h	235 Pa	1 340 rpm	1~230 V	1,7 A	0,25 kW	57 dB(A)	19,0 kg	43534401
ROOF-H/31/24/14S	2 400 m ³ /h	300 Pa	1 420 rpm	1~230 V	2,8 A	0,37 kW	60 dB(A)	22,0 kg	43534406
ROOF-H/35/34/14S	3 400 m ³ /h	385 Pa	1 430 rpm	1~230 V	3,8 A	0,55 kW	63 dB(A)	32,0 kg	43534411
ROOF-H/40/50/14S	5 000 m ³ /h	490 Pa	1 430 rpm	1~230 V	4,1 A	0,75 kW	66 dB(A)	36,0 kg	43534416
ROOF-H/45/71/14S	7 100 m ³ /h	620 Pa	1 300 rpm	1~230 V	7,5 A	1,1 kW	69 dB(A)	50,0 kg	43534421
SILNIKI SZESCIOBIEGUNOWE JEDNOFAZOWE									
ROOF-H/25/08/09S	800 m ³ /h	80 Pa	880 rpm	1~230 V	1,4 A	0,12 kW	52 dB(A)	18,0 kg	43534398
ROOF-H/28/11/09S	1 100 m ³ /h	105 Pa	880 rpm	1~230 V	1,4 A	0,12 kW	54 dB(A)	18,0 kg	43534403
ROOF-H/31/16/09S	1 600 m ³ /h	130 Pa	880 rpm	1~230 V	1,4 A	0,12 kW	57 dB(A)	20,0 kg	43534408
ROOF-H/35/22/09S	2 250 m ³ /h	170 Pa	920 rpm	1~230 V	1,6 A	0,18 kW	60 dB(A)	28,0 kg	43534413
ROOF-H/40/32/09S	3 200 m ³ /h	215 Pa	940 rpm	1~230 V	2,3 A	0,25 kW	63 dB(A)	33,0 kg	43534418
ROOF-H/45/47/09S	4 700 m ³ /h	270 Pa	930 rpm	1~230 V	2,9 A	0,37 kW	66 dB(A)	44,0 kg	43534423
ROOF-H/50/64/09S	6 400 m ³ /h	340 Pa	940 rpm	1~230 V	5,2 A	0,75 kW	69 dB(A)	55,0 kg	43534428
SILNIKI CZTEROBIEGUNOWE TROJFAZOWE									
ROOF-H/25/12/14T	1 220 m ³ /h	185 Pa	1 400 rpm	3~400 V	0,55 A	0,18 kW	54 dB(A)	19,0 kg	43534395
ROOF-H/28/17/14T	1 700 m ³ /h	235 Pa	1 410 rpm	3~400 V	0,8 A	0,25 kW	57 dB(A)	20,0 kg	43534400
ROOF-H/31/24/14T	2 400 m ³ /h	300 Pa	1 410 rpm	3~400 V	1,1 A	0,37 kW	60 dB(A)	23,0 kg	43534405
ROOF-H/35/34/14T	3 400 m ³ /h	385 Pa	1 420 rpm	3~400 V	1,6 A	0,55 kW	63 dB(A)	31,0 kg	43534410
ROOF-H/40/50/14T	5 000 m ³ /h	490 Pa	1 430 rpm	3~400 V	2,1 A	0,75 kW	66 dB(A)	36,0 kg	43534415
ROOF-H/45/71/14T	7 100 m ³ /h	620 Pa	1 430 rpm	3~400 V	2,5 A	1,1 kW	69 dB(A)	55,0 kg	43534420
ROOF-H/50/97/14T	9 700 m ³ /h	765 Pa	1 450 rpm	3~400 V	4,6 A	2,2 kW	73 dB(A)	73,0 kg	43534425
ROOF-H/56/136/14T	13 600 m ³ /h	950 Pa	1 460 rpm	3~400 V	6,7 A	3,0 kW	76 dB(A)	76,0 kg	43534430
SILNIKI SZESCIOBIEGUNOWE TROJFAZOWE									
ROOF-H/25/08/09T	800 m ³ /h	80 Pa	870 rpm	3~400 V	0,65 A	0,12 kW	52 dB(A)	17,0 kg	43534397
ROOF-H/28/11/09T	1 100 m ³ /h	105 Pa	870 rpm	3~400 V	0,65 A	0,12 kW	54 dB(A)	17,0 kg	43534402
ROOF-H/31/16/09T	1 600 m ³ /h	130 Pa	870 rpm	3~400 V	0,65 A	0,12 kW	57 dB(A)	19,0 kg	43534407
ROOF-H/35/22/09T	2 250 m ³ /h	170 Pa	900 rpm	3~400 V	0,7 A	0,18 kW	60 dB(A)	27,0 kg	43534412
ROOF-H/40/32/09T	3 200 m ³ /h	215 Pa	880 rpm	3~400 V	1,0 A	0,25 kW	63 dB(A)	31,0 kg	43534417
ROOF-H/45/47/09T	4 700 m ³ /h	270 Pa	880 rpm	3~400 V	1,3 A	0,37 kW	66 dB(A)	44,0 kg	43534422
ROOF-H/50/64/09T	6 400 m ³ /h	340 Pa	940 rpm	3~400 V	2,0 A	0,75 kW	69 dB(A)	56,0 kg	43534427
ROOF-H/56/90/09T	9 000 m ³ /h	430 Pa	940 rpm	3~400 V	2,8 A	1,1 kW	73 dB(A)	64,0 kg	43534432
ROOF-H/63/129/09T	12 900 m ³ /h	540 Pa	965 rpm	3~400 V	5,0 A	2,2 kW	74 dB(A)	105,0 kg	43534437
ROOF-H/71/184/09T	18 400 m ³ /h	690 Pa	965 rpm	3~400 V	6,2 A	3,0 kW	81 dB(A)	147,0 kg	43534442
ROOF-H/80/264/09T	26 400 m ³ /h	840 Pa	960 rpm	3~400 V	13,3 A	5,5 kW	85 dB(A)	190,0 kg	43534447

*pomiar wykonany w odległości 1,5m od wylotu, dla Q = 2/3*Q_{max}

** wartość prądu znamionowego może się różnić w zależności od producenta zastosowanego silnika elektrycznego.



CHARAKTERYSTYKI PRACY WENTYLATORÓW

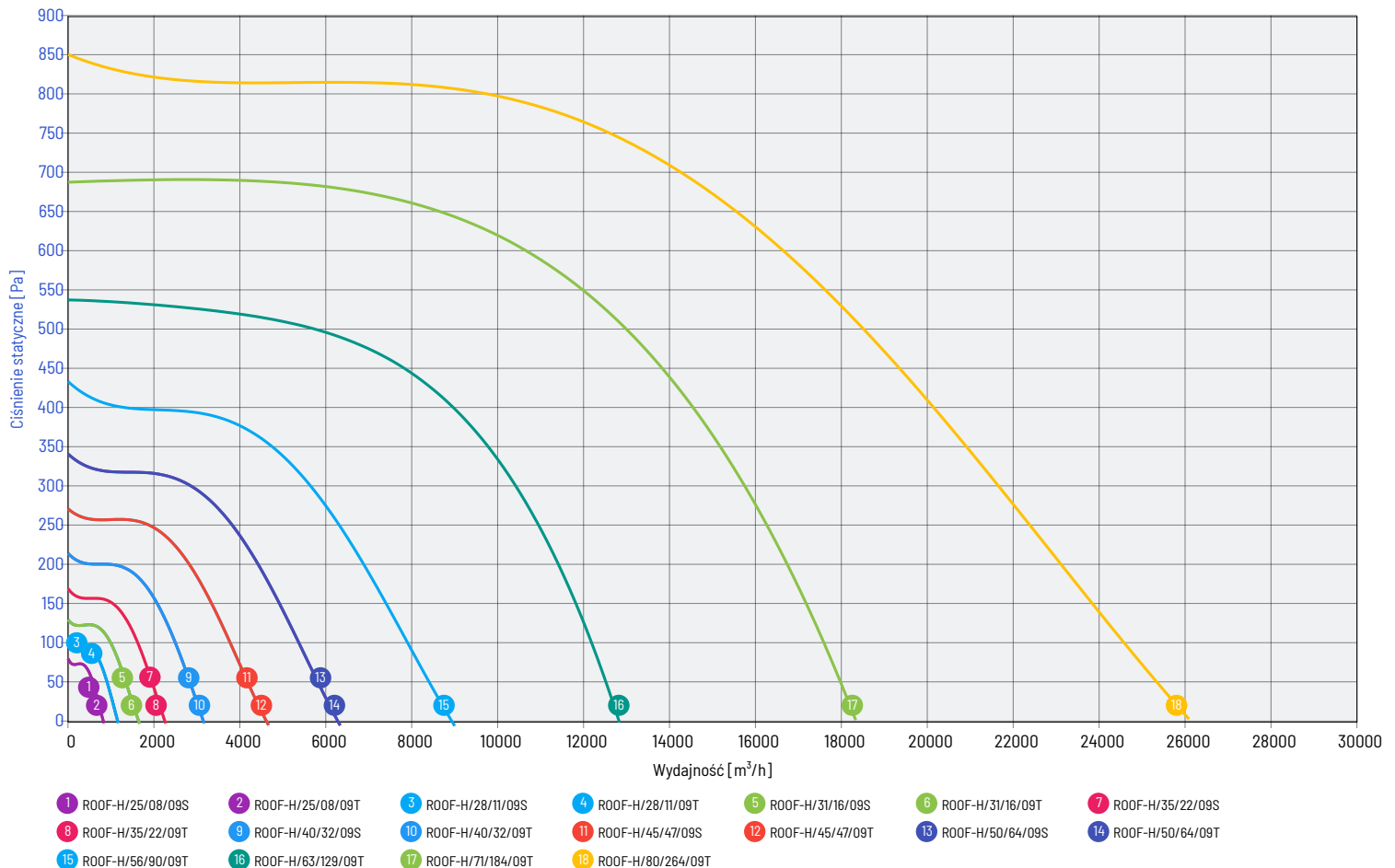
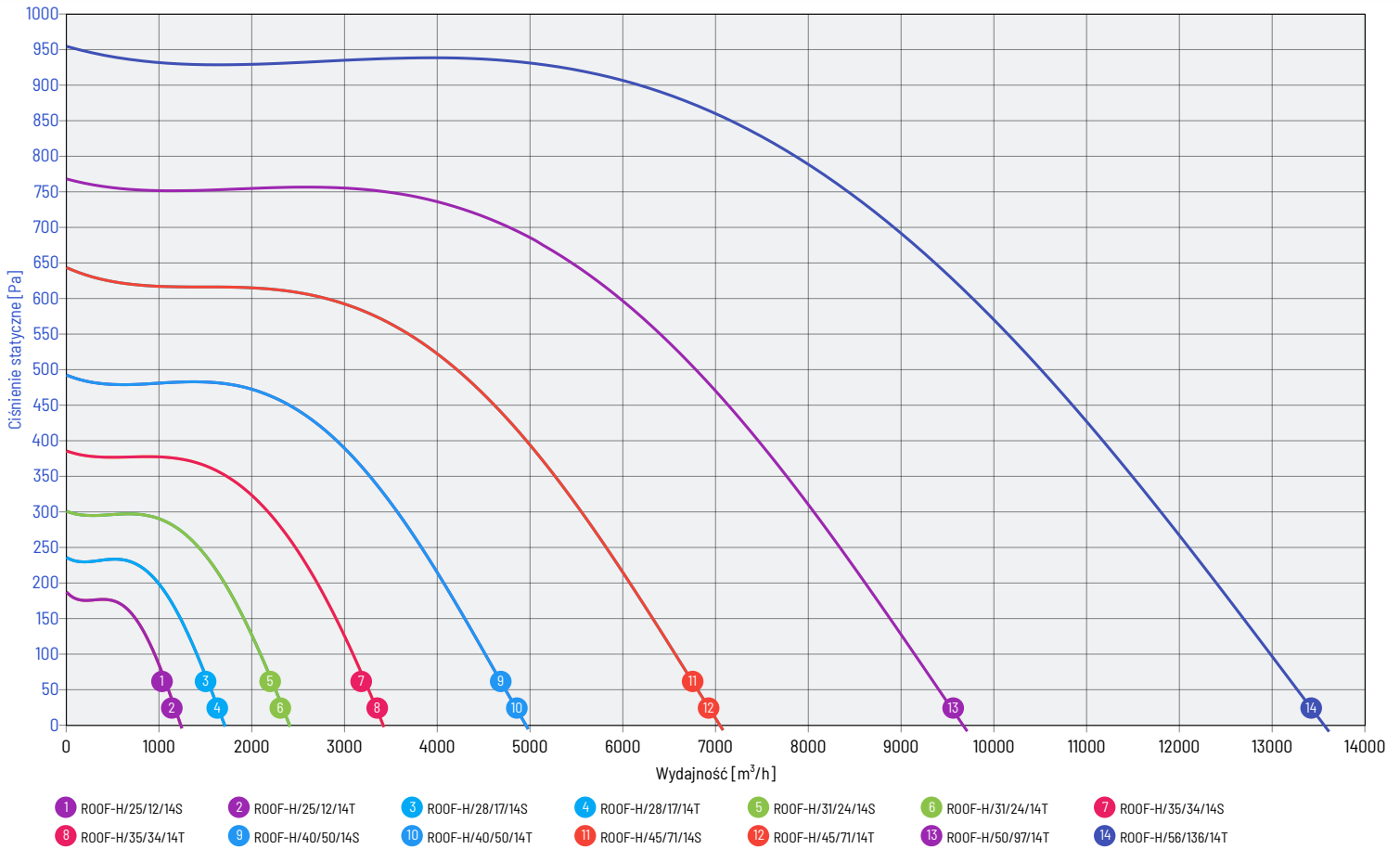

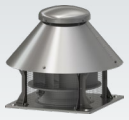

CHARAKTERYSTYKI PRACY WENTYLATORÓW

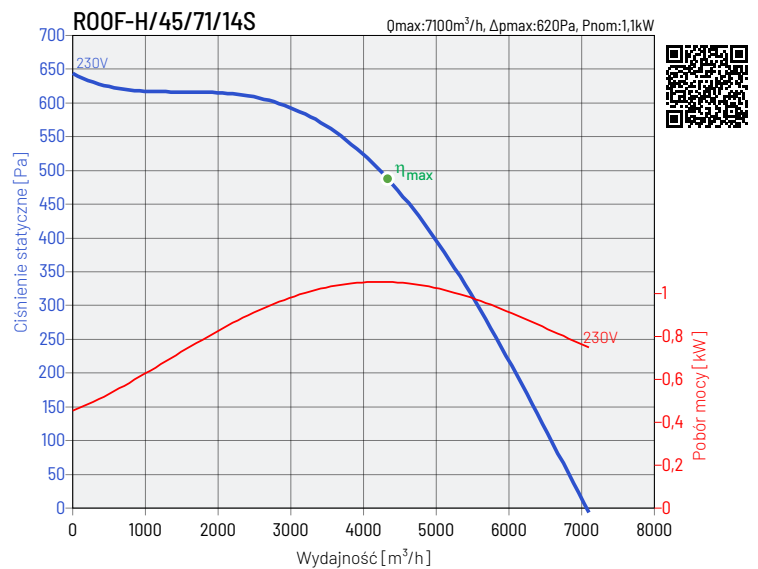
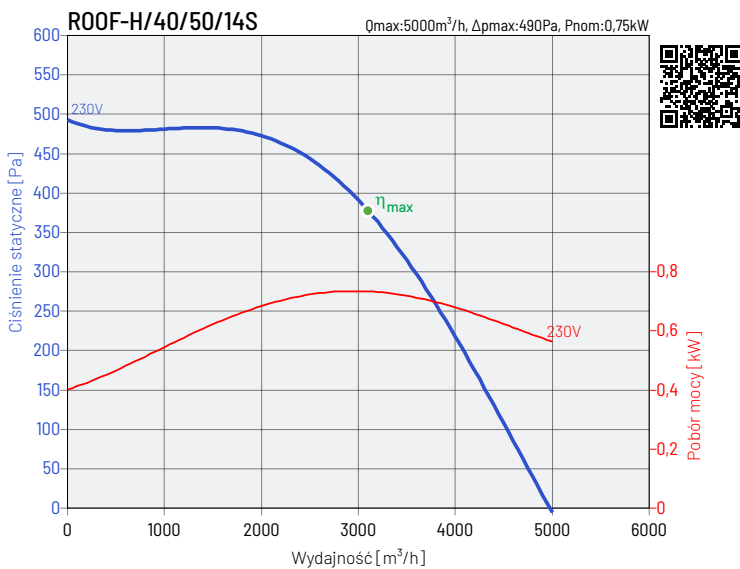
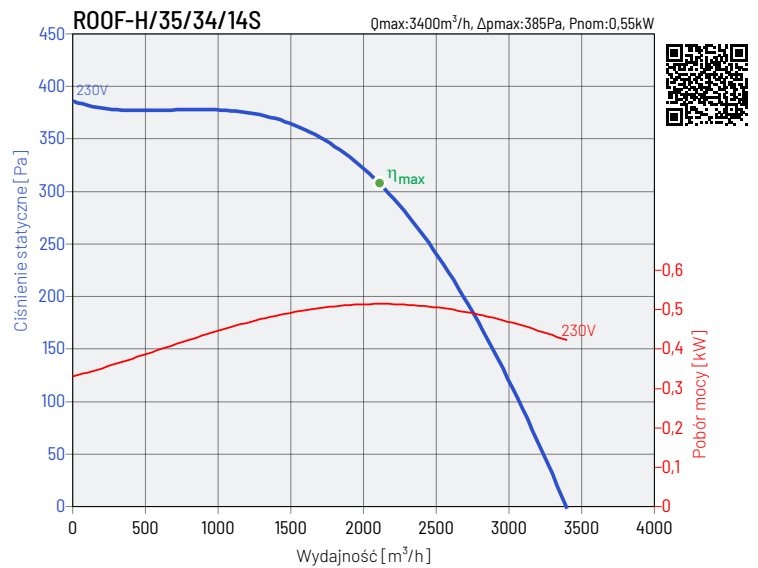
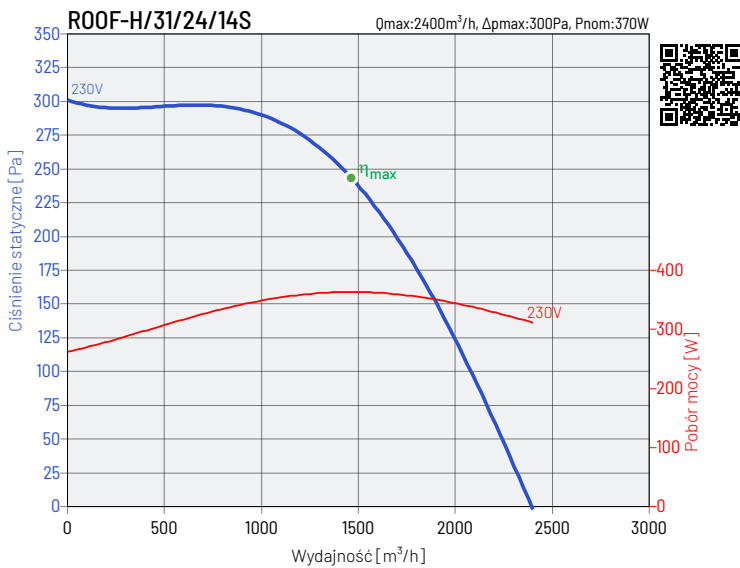
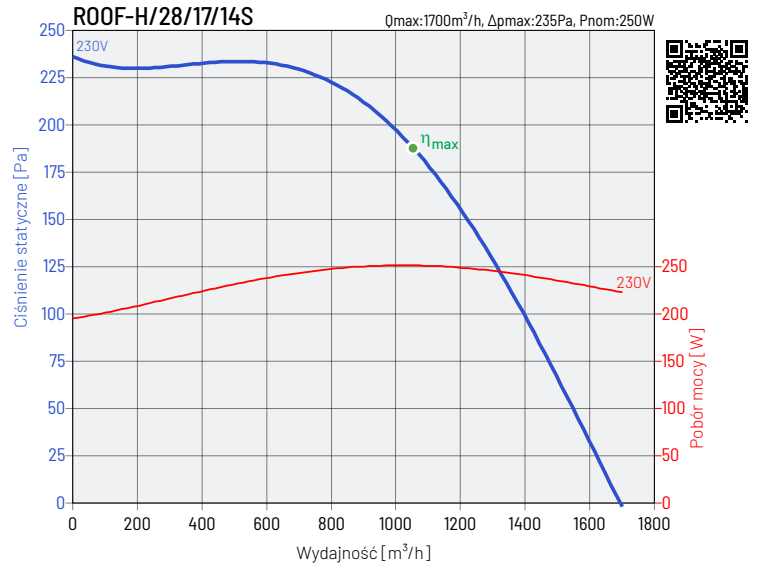
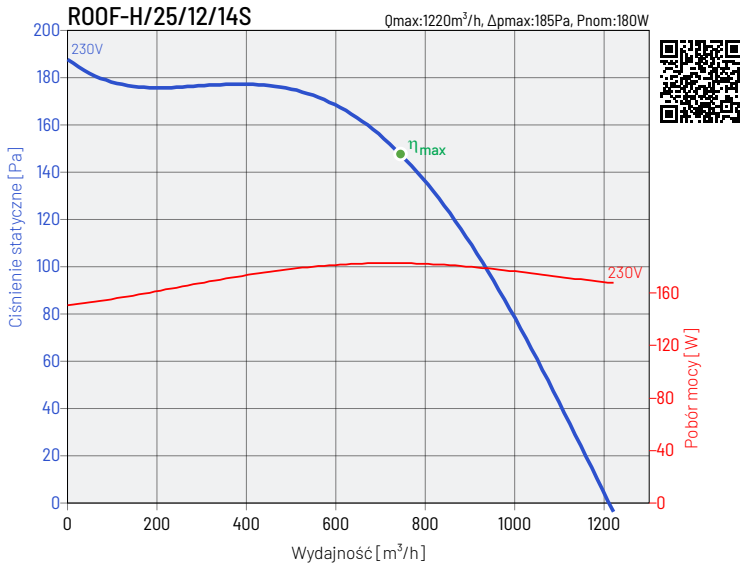



CHARAKTERYSTYKI PRACY WENTYLATORÓW

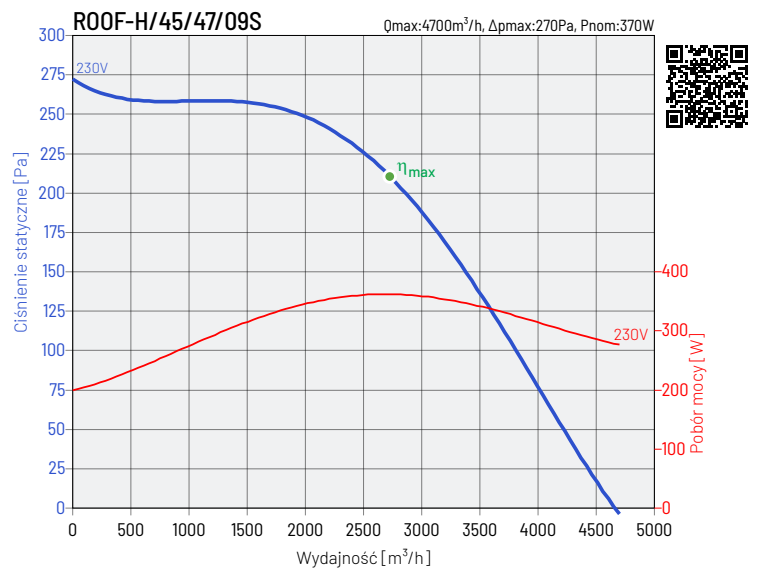
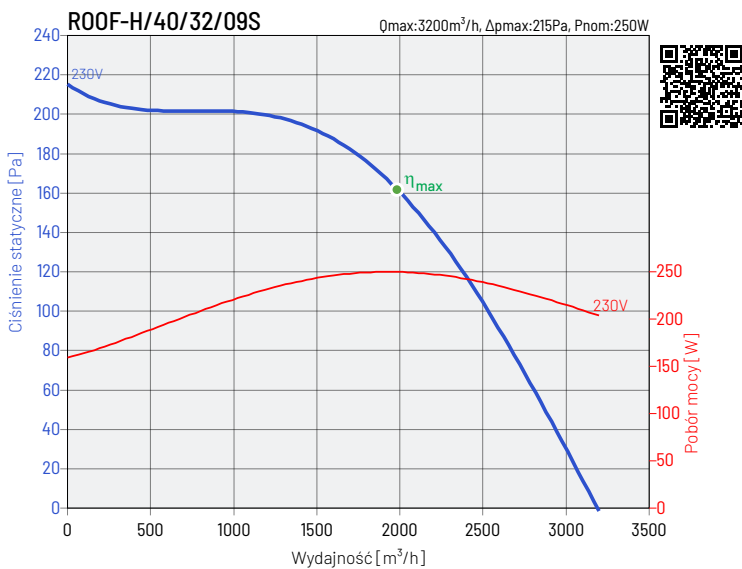
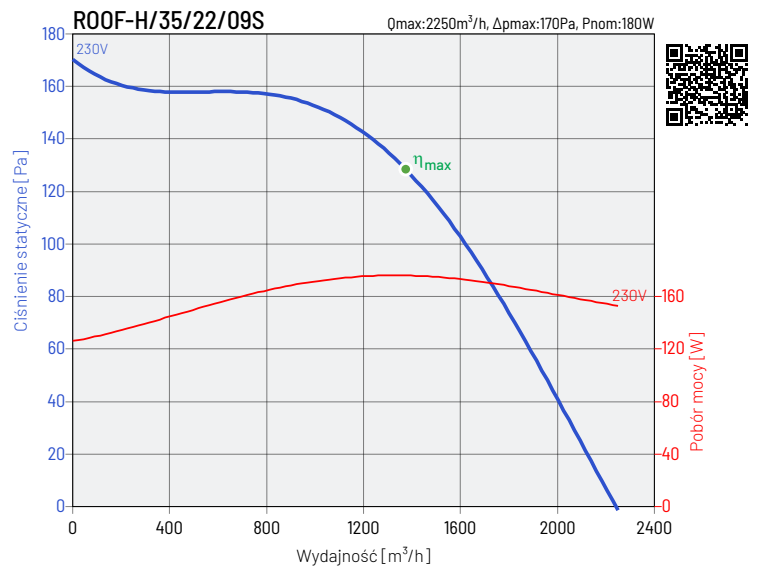
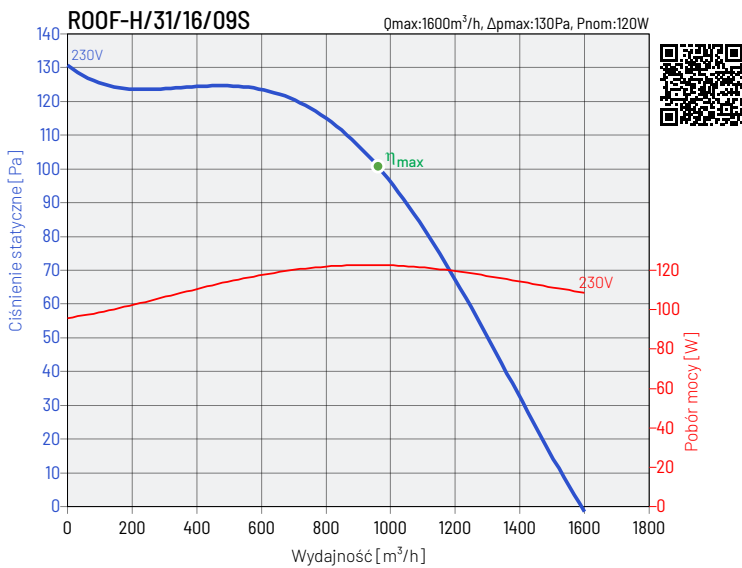
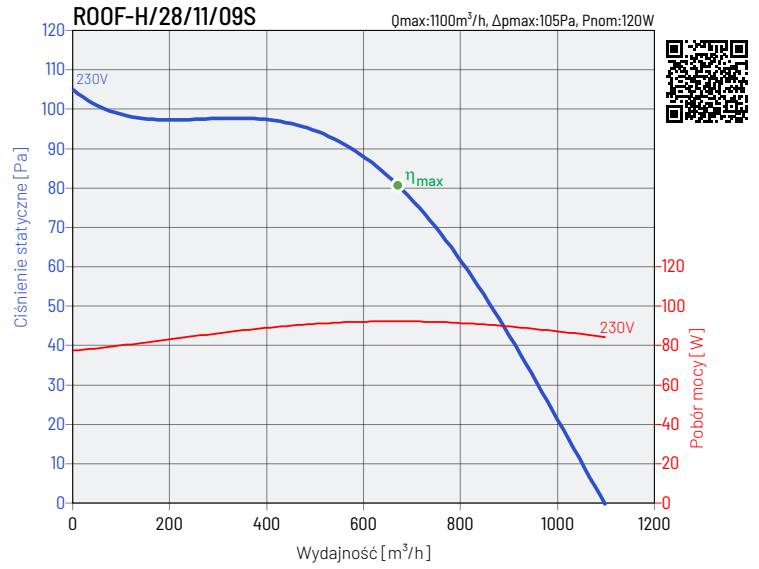
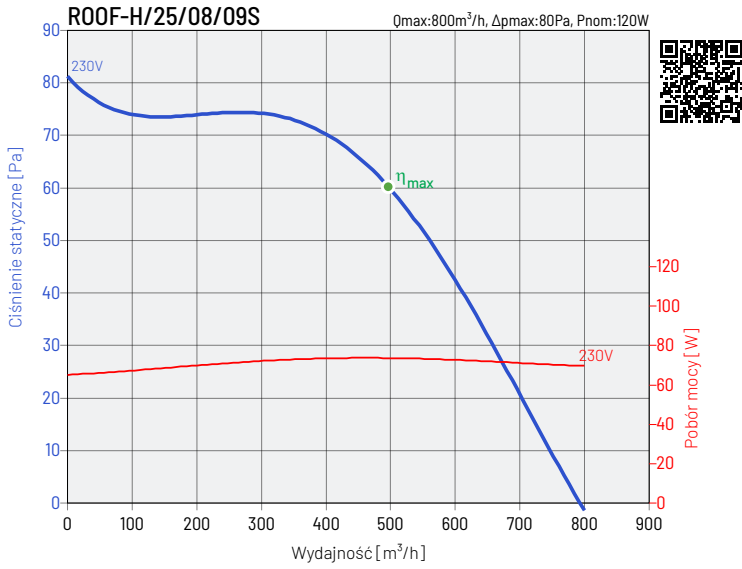

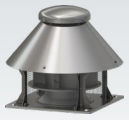

CHARAKTERYSTYKI PRACY WENTYLATORÓW

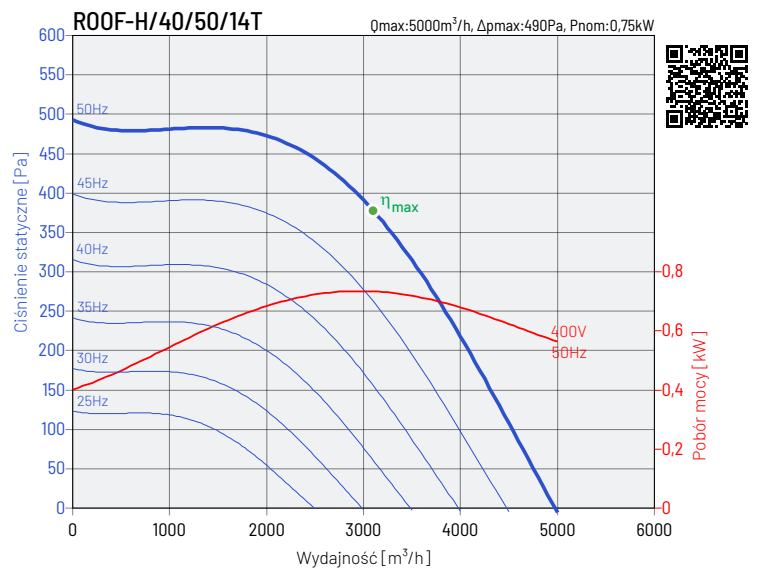
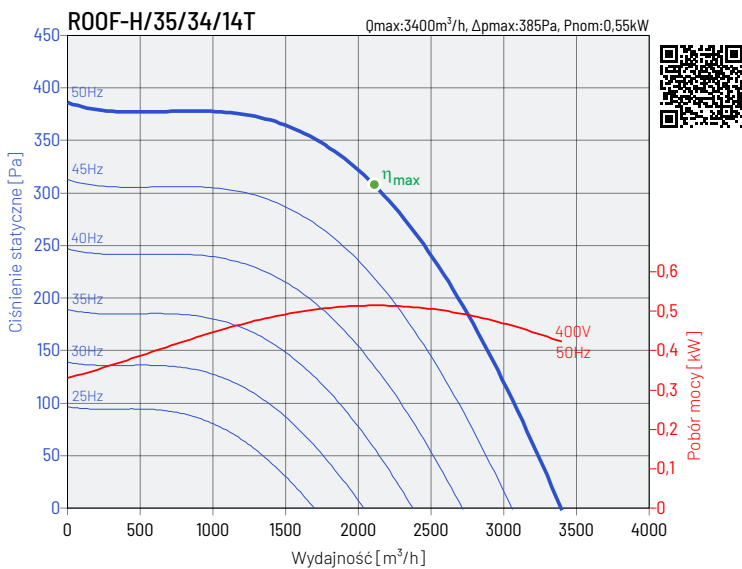
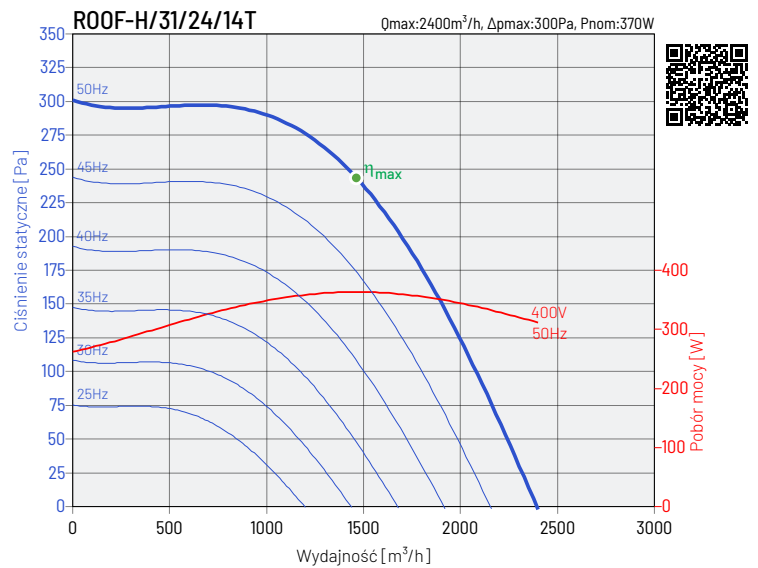
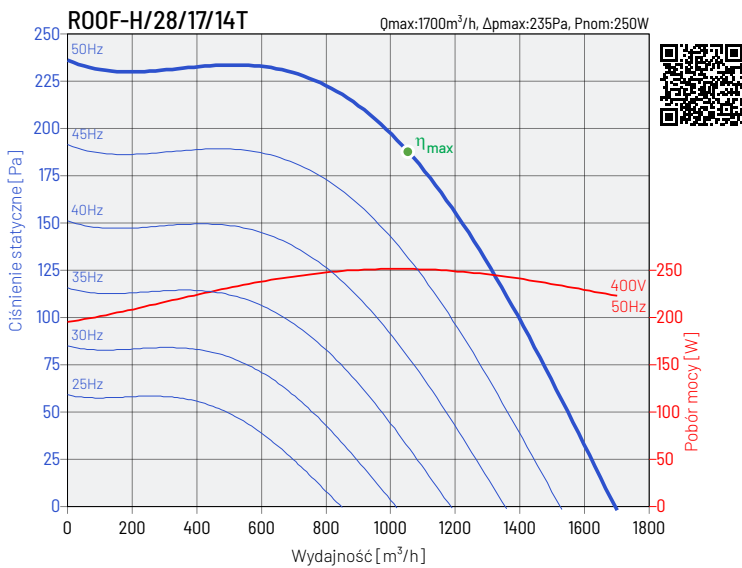
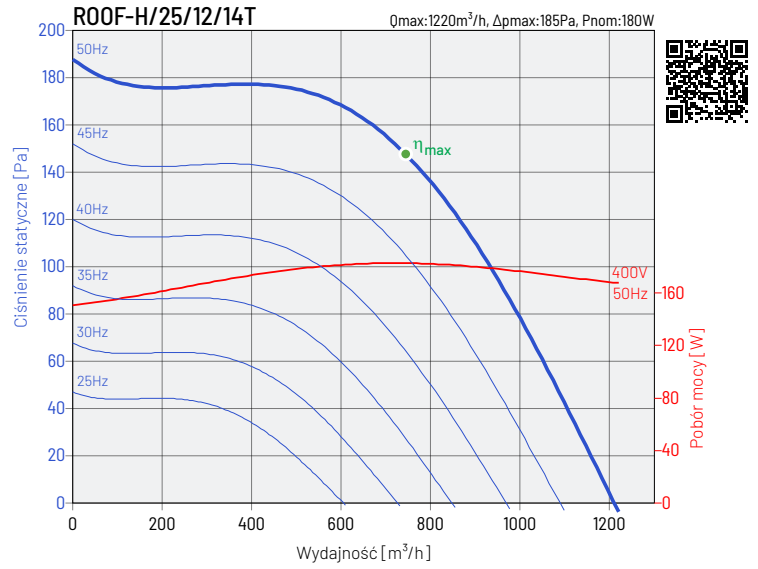
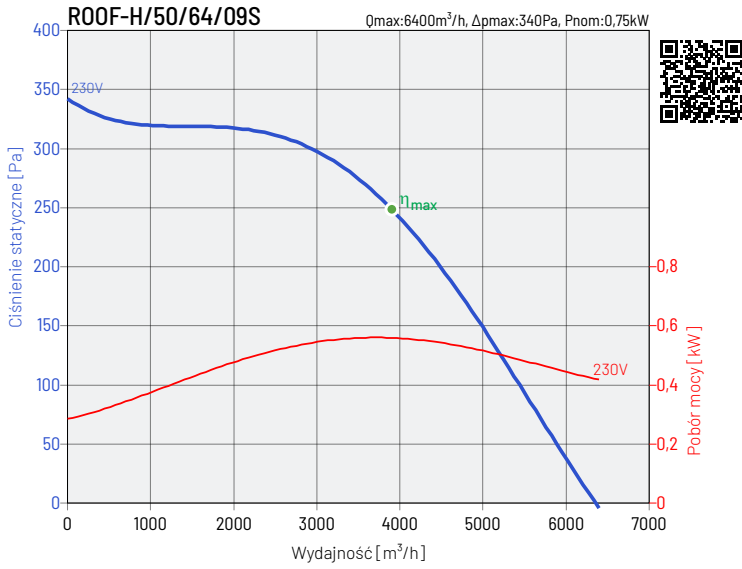

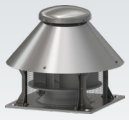

CHARAKTERYSTYKI PRACY WENTYLATORÓW

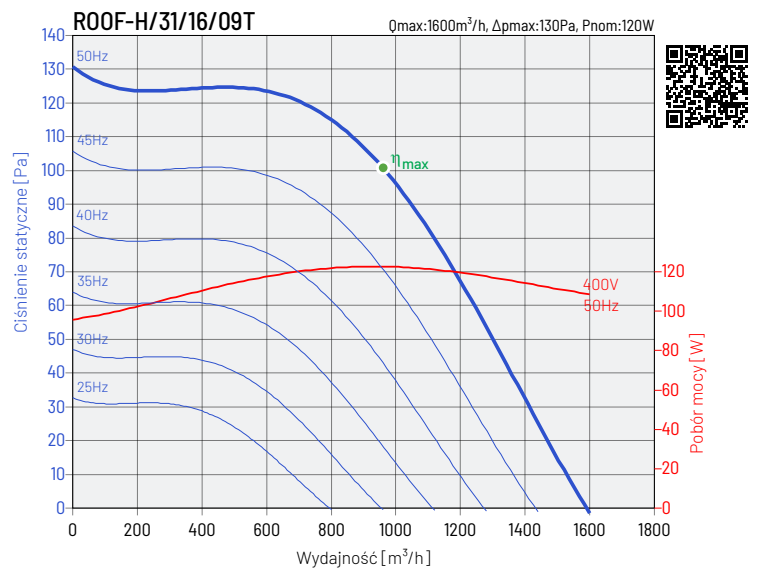
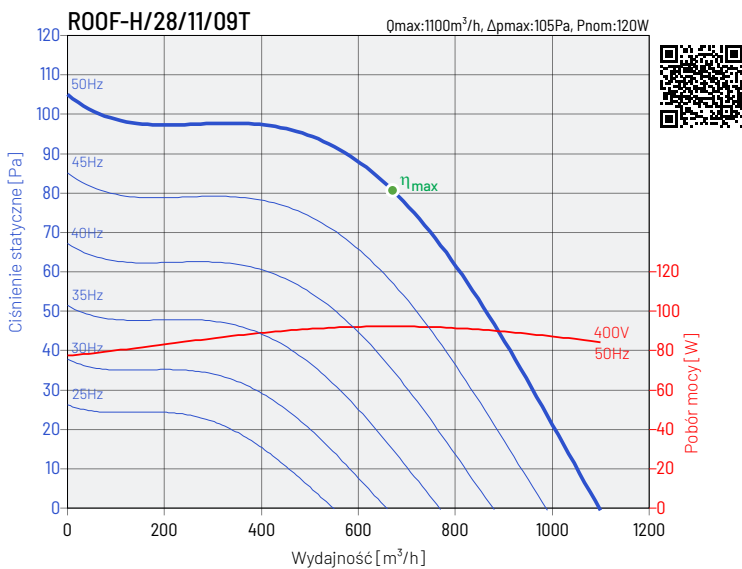
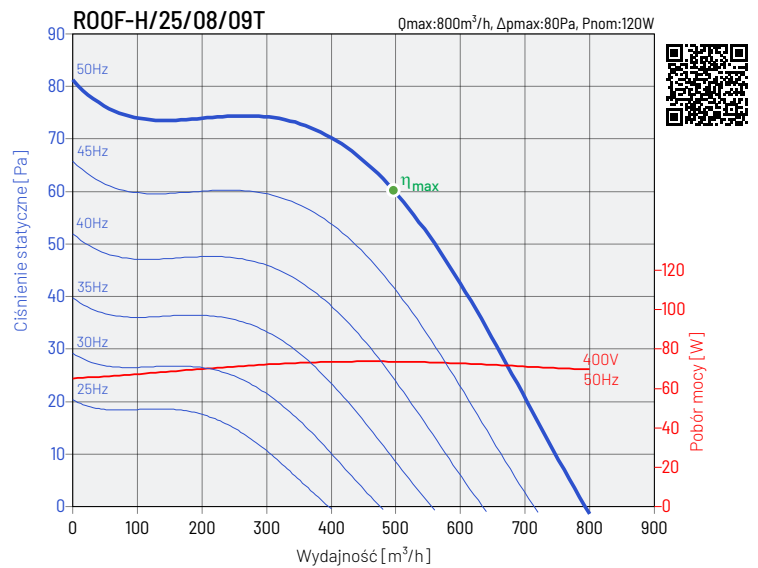
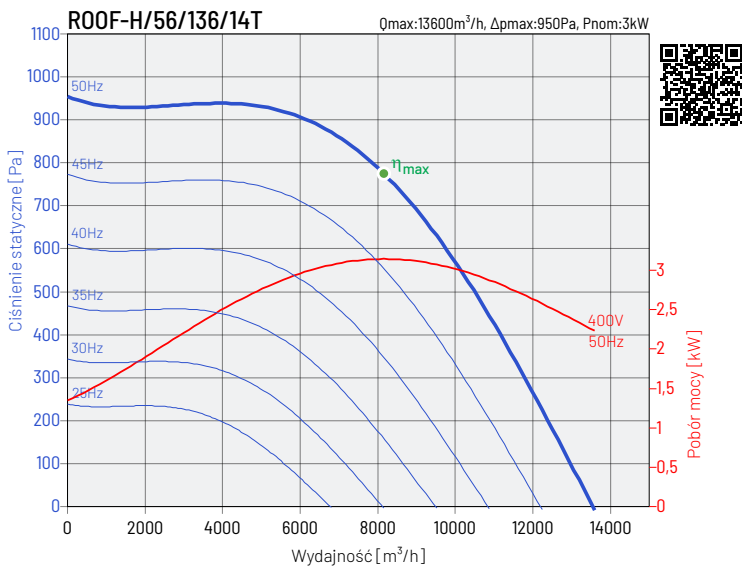
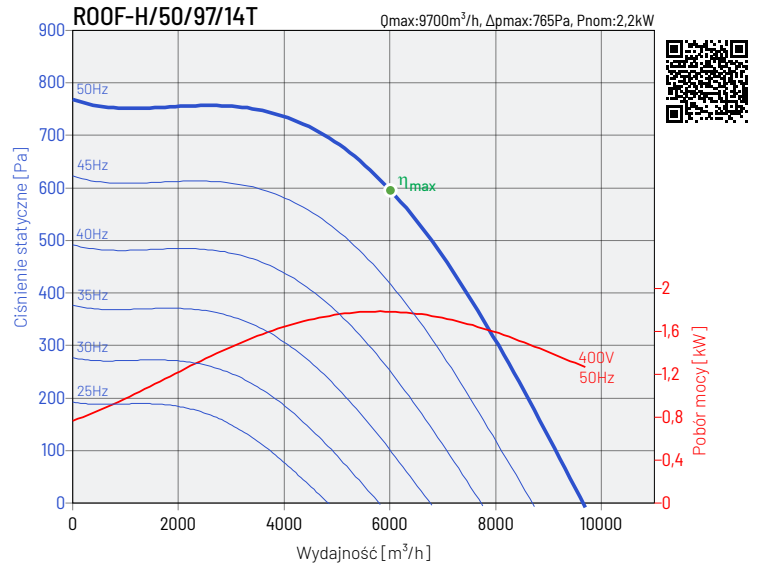
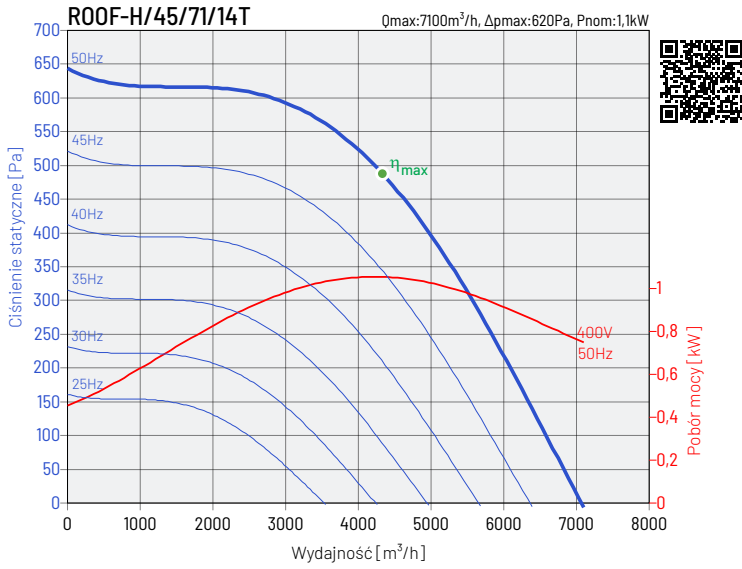

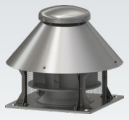

CHARAKTERYSTYKI PRACY WENTYLATORÓW

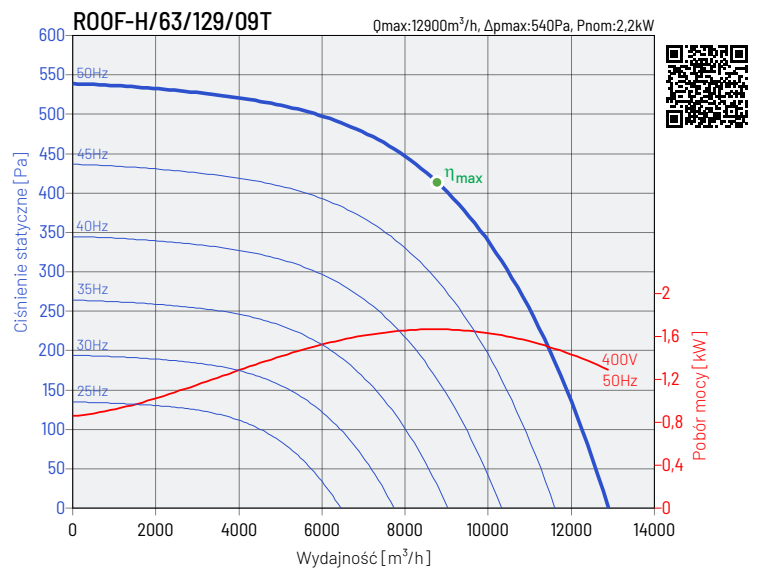
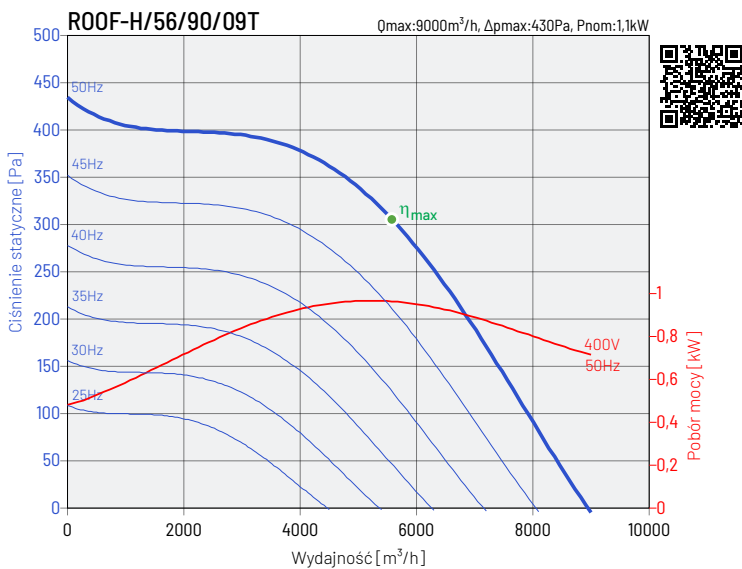
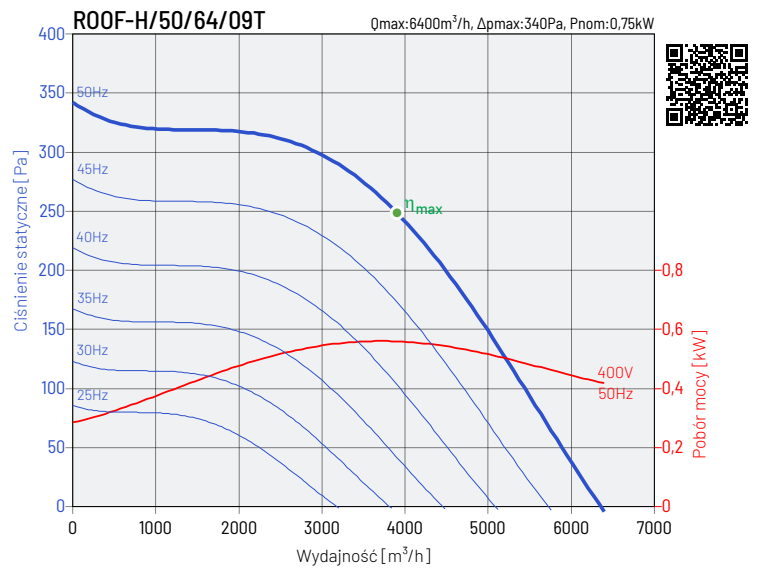
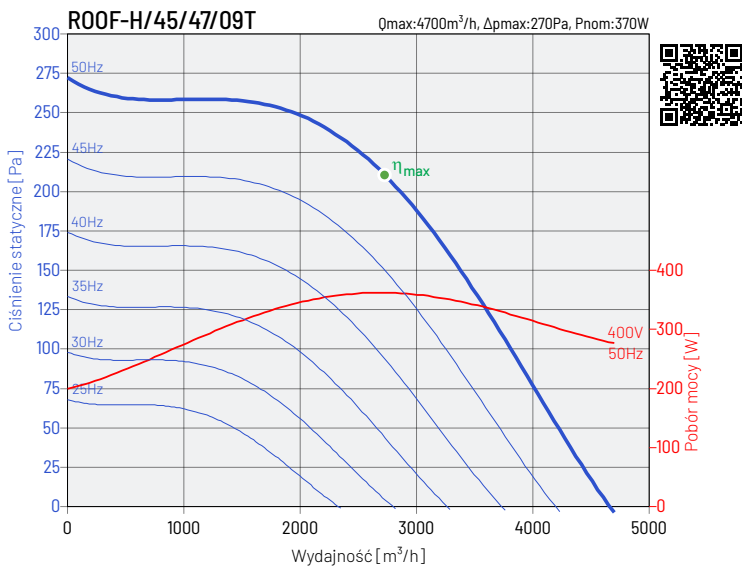
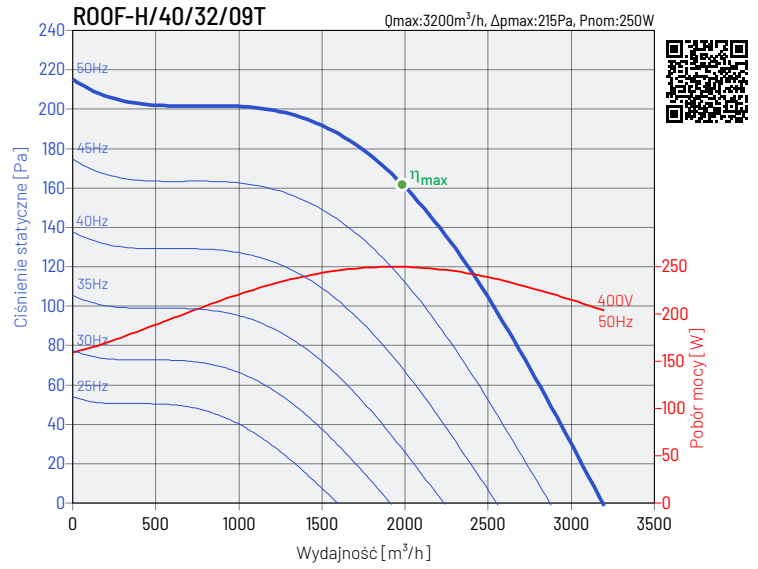
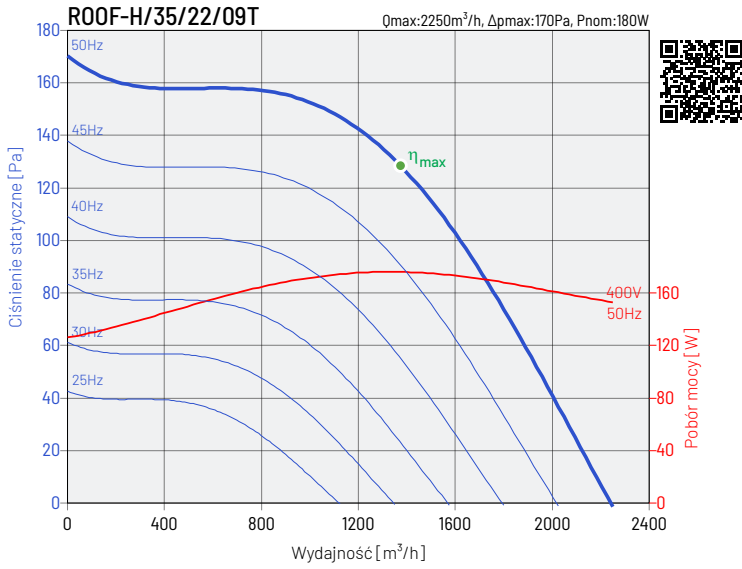

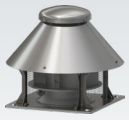

CHARAKTERYSTYKI PRACY WENTYLATORÓW

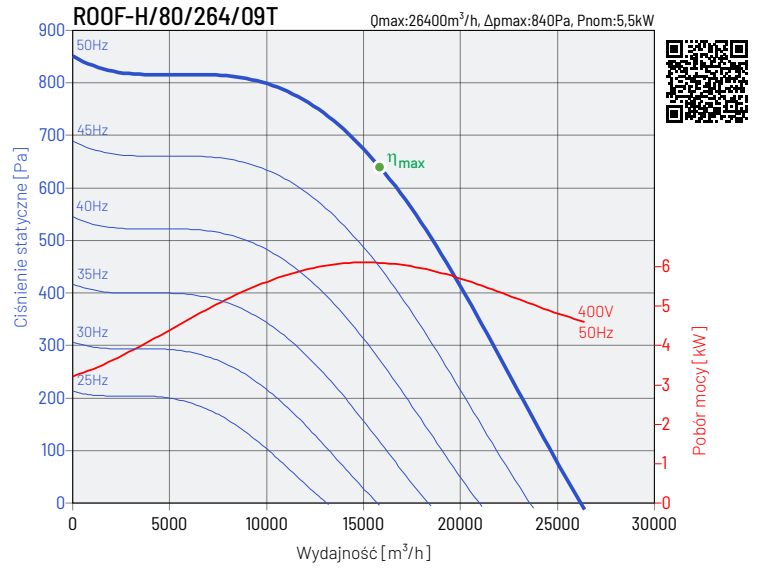
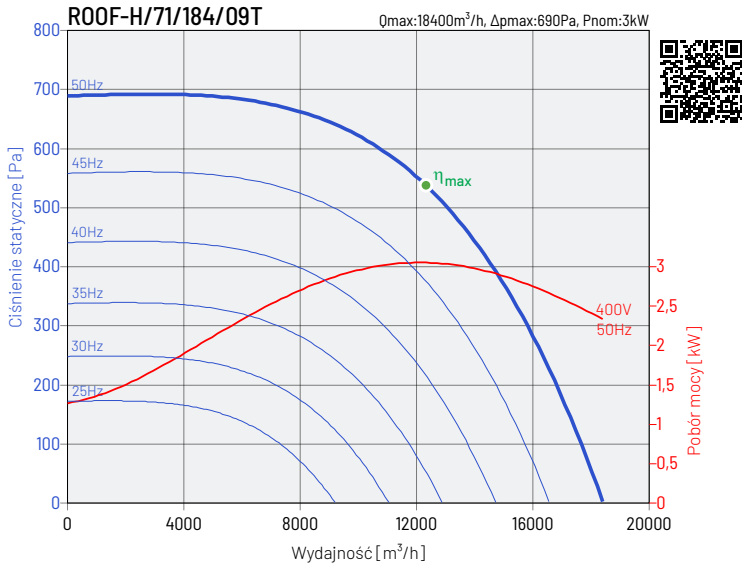

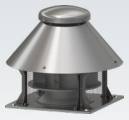

ROOF-H Wentylator dachowy

The power of AIR

WYMIARY

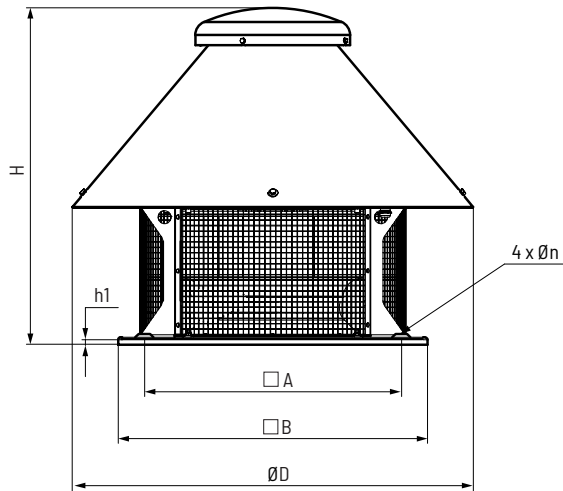

model wentylatora	A mm	B mm	ØD mm	H mm	h1 mm	Øn mm
ROOF-H/25	330	435	510	456	15	12
ROOF-H/28	330	435	510	456	15	12
ROOF-H/31	330	435	570	471	15	12
ROOF-H/35	450	560	680	606	15	12
ROOF-H/40	450	560	730	623	15	12
ROOF-H/45	535	630	800	666	15	12
ROOF-H/50	590	710	920	773	17	12
ROOF-H/56	590	710	1000	762	17	12
ROOF-H/63	750	900	1115	935	40	14
ROOF-H/71	750	900	1250	1060	40	14
ROOF-H/80	840	1100	1410	1185	40	14



ROOF-H Wentylator dachowy

The power of AIR



AKCESORIA MONTAŻOWE

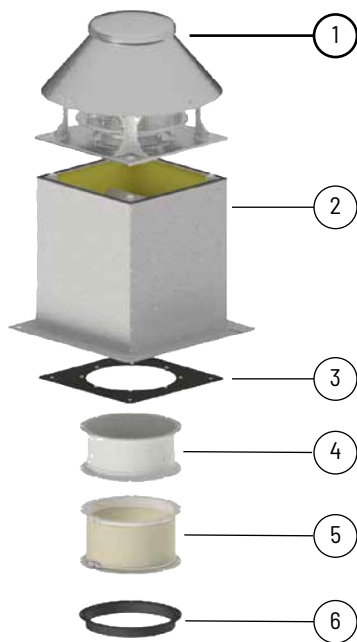

wentylator	podstawa dachowa krótka RSS	podstawa dachowa RS	podstawa dachowa RS-I	podstawa dachowa RSA	podstawa dachowa RSA-I
ROOF-H/25	RSS 435	RS 435	RS-I 435	RSA 435	RSA-I 435
ROOF-H/28	RSS 435	RS 435	RS-I 435	RSA 435	RSA-I 435
ROOF-H/31	RSS 435	RS 435	RS-I 435	RSA 435	RSA-I 435
ROOF-H/35	RSS 560	RS 560	RS-I 560	RSA 560	RSA-I 560
ROOF-H/40	RSS 560	RS 560	RS-I 560	RSA 560	RSA-I 560
ROOF-H/45	RSS 630	RS 630	RS-I 630	RSA 630	RSA-I 630
ROOF-H/50	RSS 710	RS 710	RS-I 710	RSA 710	RSA-I 710
ROOF-H/56	RSS 710	RS 710	RS-I 710	RSA 710	RSA-I 710
ROOF-H/63	RSS 905	RS 905	RS-I 905	RSA 905	RSA-I 905
ROOF-H/71	RSS 905	RS 905	RS-I 905	RSA 905	RSA-I 905
ROOF-H/80	RSS 1100	RS 1100	RS-I 1100	RSA 1100	RSA-I 1100



wentylator	złącze P	kłapa zwrotna KZD SE	złącze przeciw drganiowe ZDPO	króciec K
ROOF-H/25	P 435	KZD SE 435	ZDPO 435	K 435
ROOF-H/28	P 435	KZD SE 435	ZDPO 435	K 435
ROOF-H/31	P 435	KZD SE 435	ZDPO 435	K 435
ROOF-H/35	P 560	KZD SE 560	ZDPO 560	K 560
ROOF-H/40	P 560	KZD SE 560	ZDPO 560	K 560
ROOF-H/45	P 630	KZD SE 630	ZDPO 630	K 630
ROOF-H/50	P 710	KZD SE 710	ZDPO 710	K 710
ROOF-H/56	P 710	KZD SE 710	ZDPO 710	K 710
ROOF-H/63	P 905	KZD SE 905	ZDPO 905	K 905
ROOF-H/71	P 905	KZD SE 905	ZDPO 905	K 905
ROOF-H/80	P 1100	KZD SE 1100	ZDPO 1100	K 1100

Numery artykułów

43526520	RSS 435	43526020	RS 435	43526120	RSA 435	43526310	P 435	43527410	ZDPO 435	43526410	K 435
43526530	RSS 560	43526030	RS 560	43526130	RSA 560	43526320	P 560	43527420	ZDPO 560	43526420	K 560
43526540	RSS 630	43526040	RS 630	43526140	RSA 630	43526330	P 630	43527430	ZDPO 630	43526430	K 630
43526550	RSS 710	43526050	RS 710	43526150	RSA 710	43526340	P 710	43527440	ZDPO 710	43526440	K 710
43526560	RSS 905	43526060	RS 905	43526160	RSA 905	43526350	P 905	43527450	ZDPO 905	43526450	K 905
43526570	RSS 1100	43526070	RS 1100	43526170	RSA 1100	43526360	P 1100	43527460	ZDPO 1100	43526460	K 1100
43526580	RSS 1250	43526080	RS 1250	43526180	RSA 1250	43526370	P 1250	43527470	ZDPO 1250	43526470	K 1250
		43526721	RS-I 435	43526821	RSA-I 435	43527312	KZD SE 435				
		43526731	RS-I 560	43526831	RSA-I 560	43527322	KZD SE 560				
		43526741	RS-I 630	43526841	RSA-I 630	43527332	KZD SE 630				
		43526751	RS-I 710	43526851	RSA-I 710	43527342	KZD SE 710				
		43526761	RS-I 905	43526861	RSA-I 905	43527352	KZD SE 905				
		43526771	RS-I 1100	43526871	RSA-I 1100	43527362	KZD SE 1100				
		43526781	RS-I 1250	43526881	RSA-I 1250	43527372	KZD SE 1250				



AKCESORIA ELEKTRYCZNE



wentylator	termostat ścienny	termostat kanałowy	czujnik temperatury	czujnik zanieczyszczenia	higrostat
	TS*	TK-21	do TK-21	SQA	HIG-2
ROOF-H/25/12/14S	TS	TK-21	Czujnik TK-21	SQA	HIG-2
ROOF-H/28/17/14S	TS	TK-21	Czujnik TK-21	SQA + DILM7-10	HIG-2 + DILM7-10
ROOF-H/31/24/14S	TS + DILM7-10	TK-21	Czujnik TK-21	SQA + DILM7-10	HIG-2 + DILM7-10
ROOF-H/35/34/14S	TS + DILM7-10	TK-21 + DILM7-10	Czujnik TK-21	SQA + DILM7-10	HIG-2 + DILM7-10
ROOF-H/40/50/14S	TS + DILM7-10	TK-21 + DILM7-10	Czujnik TK-21	SQA + DILM7-10	HIG-2 + DILM7-10
ROOF-H/45/71/14S	TS + DILM7-10	TK-21 + DILM7-10	Czujnik TK-21	SQA + DILM7-10	HIG-2 + DILM7-10
ROOF-H/25/08/09S	TS	TK-21	Czujnik TK-21	SQA	HIG-2
ROOF-H/28/11/09S	TS	TK-21	Czujnik TK-21	SQA	HIG-2
ROOF-H/31/16/09S	TS	TK-21	Czujnik TK-21	SQA	HIG-2
ROOF-H/35/22/09S	TS	TK-21	Czujnik TK-21	SQA	HIG-2
ROOF-H/40/32/09S	TS	TK-21	Czujnik TK-21	SQA + DILM7-10	HIG-2 + DILM7-10
ROOF-H/45/47/09S	TS + DILM7-10	TK-21	Czujnik TK-21	SQA + DILM7-10	HIG-2 + DILM7-10
ROOF-H/50/64/09S	TS + DILM7-10	TK-21 + DILM7-10	Czujnik TK-21	SQA + DILM7-10	HIG-2 + DILM7-10
ROOF-H/25/12/14T	TS + DILM7-10	TK-21 + DILM7-10	Czujnik TK-21	SQA + DILM7-10	HIG-2 + DILM7-10
ROOF-H/28/16/14T	TS + DILM7-10	TK-21 + DILM7-10	Czujnik TK-21	SQA + DILM7-10	HIG-2 + DILM7-10
ROOF-H/31/23/14T	TS + DILM7-10	TK-21 + DILM7-10	Czujnik TK-21	SQA + DILM7-10	HIG-2 + DILM7-10
ROOF-H/35/33/14T	TS + DILM7-10	TK-21 + DILM7-10	Czujnik TK-21	SQA + DILM7-10	HIG-2 + DILM7-10
ROOF-H/40/48/14T	TS + DILM7-10	TK-21 + DILM7-10	Czujnik TK-21	SQA + DILM7-10	HIG-2 + DILM7-10
ROOF-H/45/68/14T	TS + DILM7-10	TK-21 + DILM7-10	Czujnik TK-21	SQA + DILM7-10	HIG-2 + DILM7-10
ROOF-H/50/93/14T	TS + DILM7-10	TK-21 + DILM7-10	Czujnik TK-21	SQA + DILM7-10	HIG-2 + DILM7-10
ROOF-H/56/130/14T	TS + DILM7-10	TK-21 + DILM7-10	Czujnik TK-21	SQA + DILM7-10	HIG-2 + DILM7-10
ROOF-H/25/08/09T	TS + DILM7-10	TK-21 + DILM7-10	Czujnik TK-21	SQA + DILM7-10	HIG-2 + DILM7-10
ROOF-H/28/11/09T	TS + DILM7-10	TK-21 + DILM7-10	Czujnik TK-21	SQA + DILM7-10	HIG-2 + DILM7-10
ROOF-H/31/16/09T	TS + DILM7-10	TK-21 + DILM7-10	Czujnik TK-21	SQA + DILM7-10	HIG-2 + DILM7-10
ROOF-H/35/21/09T	TS + DILM7-10	TK-21 + DILM7-10	Czujnik TK-21	SQA + DILM7-10	HIG-2 + DILM7-10
ROOF-H/40/31/09T	TS + DILM7-10	TK-21 + DILM7-10	Czujnik TK-21	SQA + DILM7-10	HIG-2 + DILM7-10
ROOF-H/45/46/09T	TS + DILM7-10	TK-21 + DILM7-10	Czujnik TK-21	SQA + DILM7-10	HIG-2 + DILM7-10
ROOF-H/50/62/09T	TS + DILM7-10	TK-21 + DILM7-10	Czujnik TK-21	SQA + DILM7-10	HIG-2 + DILM7-10
ROOF-H/56/88/09T	TS + DILM7-10	TK-21 + DILM7-10	Czujnik TK-21	SQA + DILM7-10	HIG-2 + DILM7-10
ROOF-H/63/125/09T	TS + DILM7-10	TK-21 + DILM7-10	Czujnik TK-21	SQA + DILM7-10	HIG-2 + DILM7-10
ROOF-H/71/178/09T	TS + DILM7-10	TK-21 + DILM7-10	Czujnik TK-21	SQA + DILM7-10	HIG-2 + DILM7-10
ROOF-H/80/256/09T	TS + DILM15-10	TK-21 + DILM15-10	Czujnik TK-21	SQA + DILM15-10	HIG-2 + DILM15-10

* silnik jednofazowe wykorzystać wszystkie try w styczniku



ROOF-H Wentylator dachowy

The power of AIR



AKCESORIA ELEKTRYCZNE



wentylator	regulator transformatorowy 2-nastawowy	falownik
	SC2A	L
ROOF-H/25/12/14T	SC2A4-15L55	L 0.4kW
ROOF-H/28/16/14T	SC2A4-15L55	L 0.4kW
ROOF-H/31/23/14T	SC2A4-15L55	L 0.4kW
ROOF-H/35/33/14T	SC2A4-25L55	L 0.75kW
ROOF-H/40/48/14T	SC2A4-25L55	L 0.75kW
ROOF-H/45/68/14T	SC2A4-40L55	L 1.5kW
ROOF-H/50/93/14T	SC2A4-60L55	L 2.2kW
ROOF-H/56/130/14T	SC2A4-80L55	L 4.0kW
ROOF-H/25/08/09T	SC2A4-15L55	L 0.4kW
ROOF-H/28/11/09T	SC2A4-15L55	L 0.4kW
ROOF-H/31/16/09T	SC2A4-15L55	L 0.4kW
ROOF-H/35/21/09T	SC2A4-15L55	L 0.4kW
ROOF-H/40/31/09T	SC2A4-15L55	L 0.4kW
ROOF-H/45/46/09T	SC2A4-15L55	L 0.4kW
ROOF-H/50/62/09T	SC2A4-25L55	L 0.75kW
ROOF-H/56/88/09T	SC2A4-40L55	L 1.5kW
ROOF-H/63/125/09T	SC2A4-40L55	L 2.2kW
ROOF-H/71/178/09T	SC2A4-80L55	L 4.0kW
ROOF-H/80/256/09T	-	L 5.5kW

Numery artykułów

91040997 DILM7-10	40025270 SC2A4-15L55	40016302 L 0.4kW
91040666-42 DILM15-10	40025272 SC2A4-25L55	40016312 L 0.75kW
91040905 DILM25-10	40025274 SC2A4-40L55	40016322 L 1.5kW
91040666 DILM40-10	40025276 SC2A4-60L55	40016332 L 2.2kW
40025345 TS	40025278 SC2A4-80L55	40016352 L 4.0kW
40025320 TK-21		40016362 L 5.5kW
40025140 SQA		40016383 L 11kW
40025150 HIG-2		40016412 L 18,5kW